

The
**Wooden
PoolStore**

INSTALLATION INSTRUCTIONS ALUMINIUM COPING RETROFIT PACK







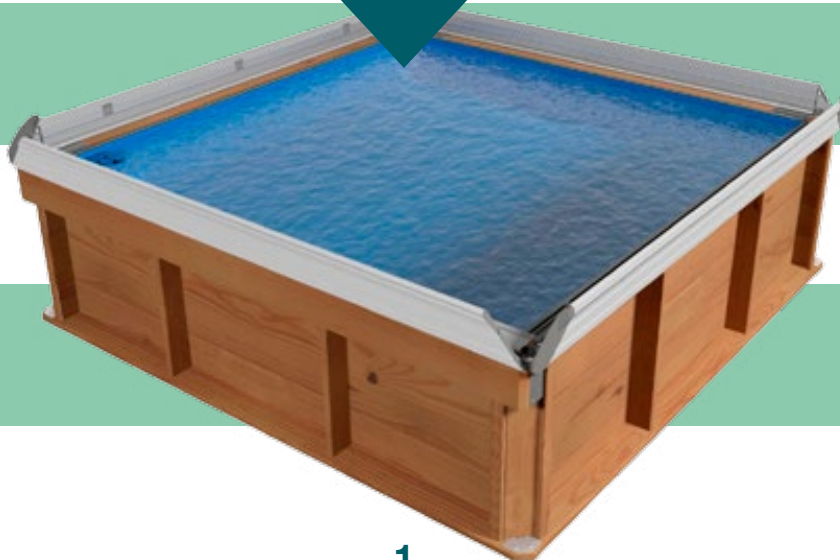







(to be read carefully)

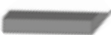
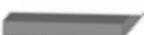

Wooden coping
to aluminium coping



1.1 - ALUMINIUM COPING RETROFIT PACK - LISTS OF PARTS

102	Countersunk screws 5x60	Qty: 40	108	Round head screws 4.2x19	Qty: 16	109	Countersunk screws 4.2x9.5	Qty: 6
								
110	Round head screws 4.2x9.5	Qty: 8	212 A	Lacquered aluminium coping 2208 x 145 x 32	Qty: 3	212 B	Lacquered aluminium coping for cover pit 2208 x 145 x 32	Qty: 1
								
217	Small corner batten 480mm	Qty: 2	218	Large corner batten 607mm	Qty: 2	402	Centering shoe	Qty: 8
								
404	Safety stop	Qty: 6	601	Left-hand coping, blocking plug	Qty: 2	602	Left-hand coping, blocking plug	Qty: 2
								
603	Left-hand coping plug	Qty: 2	604	Right-hand coping plug	Qty: 2	606	Warning label	Qty: 2
								



Although the screws shown opposite are included in the sacht, they are not used to retrofit aluminium coping to the pool:

107	Countersunk screws 3.0 x 25	Qty: 4
		

1.2 - DISMANTLING THE WOODEN COPING



402 x8

Unscrew the 8 centering shoes that are blocking the sideways movement of the copings and remove them.



Remove the 4 wooden copings and the aluminium liner locking track, along with the two support brackets (219) from the coping module on the cover pit side, and the 6 safety stops (404) from the two coping modules adjacent to the cover pit.

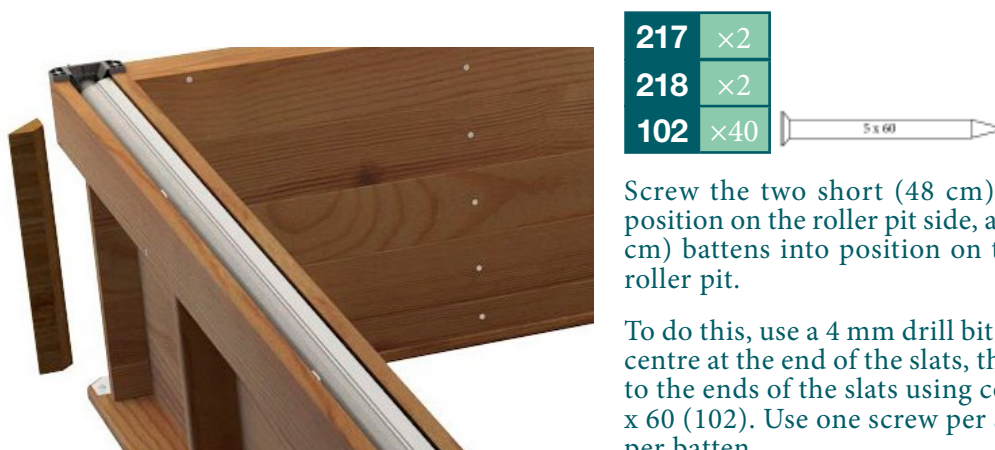
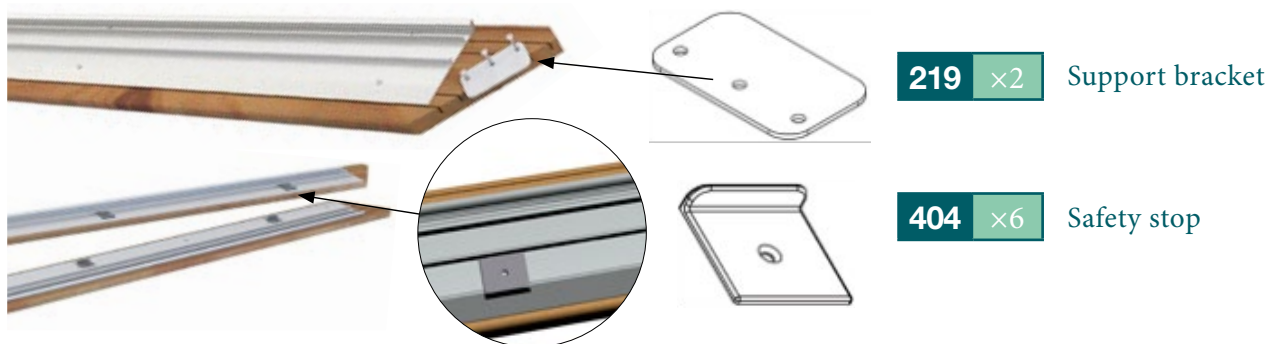

Screw the two short (48 cm) corner battens into position on the roller pit side, and the two long (60.7 cm) battens into position on the side opposite the roller pit.

To do this, use a 4 mm drill bit to make a hole in the centre at the end of the slats, then fasten the battens to the ends of the slats using countersunk screws, 5 x 60 (102). Use one screw per slat, that is 10 screws per batten.

1.3 - INSTALLING THE ALUMINIUM COPING

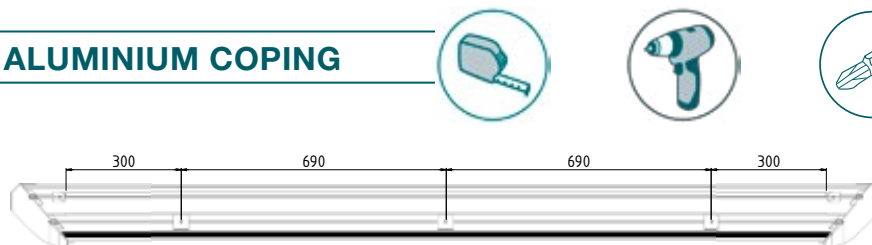
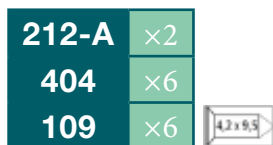

Coping modules adjacent to the roller pit:

Mount three safety stops (404) on each coping at the exact positions shown on the diagram above. Use one cross head countersunk screw 4.2 x 9.5 (109) per stop.

Safety stops must be positioned such that:

- the screw fits into the groove
- the edge of the stop should press against the central ridge of the coping so that the stop cannot rotate around its screw.



Push the left-hand coping blocking plug (601) and the right-hand coping blocking plug (602) into each side of two aluminium copings (212-A), and screw them into position using 2 screws (108) per plug.



212	×2
603	×2
604	×2
108	×8



Coping modules on the cover pit side and the side opposite the cover pit:

Push a left-hand coping plug (603) and a right-hand coping plug (604) into position on each side of the coping for the roller pit side (212-B) and the remaining coping 212-A. Use two screws (108) per plug, take care not to over-tighten.



402	×8
110	×8



Slide the aluminium coping modules (212-A) onto the hinges of the PVC Hung locking track (15 cm) and slide the coping module 212-B onto the (199 cm) Hung locking track on the roller pit side. Take care to centre the coping modules on their supports..

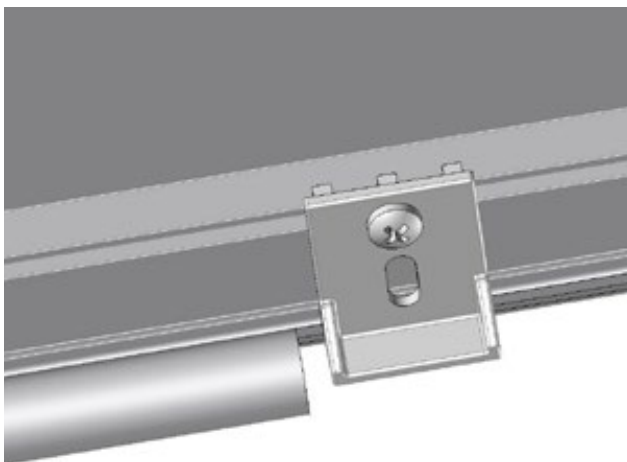

Screw the coping centring shoes (402) into position, inserting a round head screw 4.2 x 9.5 (110) into the slot on each shoe, except for the two stops on the roller put coping module in which case the screws are inserted through a circular hole, to stop the coping from sliding from side to side. To do this:

- The shoe must be positioned opposite the hinge, and press against both the aluminium coping (212) and the PVC Hung locking track.
- The screw must fit into the groove in the coping that is closest to the hinge.
- On the roller side, the three spurs on the shoe must press against the highest exterior wall of the groove.
- On the other three sides, the central spur of the shoe must fit into the groove, and the other two spurs should be located on either side of the groove so that the shoe cannot rotate around its screw.

Close the coping modules to check their position. Move the shoes if necessary by adjusting the position of the screw in the slot.

Apply the warning label, which states that the aluminium coping may become very hot when exposed to very strong sunlight, to two of the four coping modules.