

THERMOTEC INVERTER SWIMMING POOL HEAT PUMP

WI-FI MODULE USER MANUAL

FOR ALL VERTICAL AND
HORIZONTAL MODELS



Version 1.0

CONTENTS

1 The brief introduction of WIFI module	1
1.1 Components of the WIFI module	
1.2 Description of the WIFI module	1
2 The installation of WIFI module	2
2.1 Opening the heat pump	2
2.2 Connection	2
2.3 Reinstall	3
3 Using the WIFI module	3
3.1 WIFI module operation	3
3.2 Download the APP	4
3.3 Register	5
3.4 Configuration	6
4 Operation and use of APP	8
4.1 The meaning of main icons	8
4.2 Main Functions	9
4.3 Other Functions	14
5 FAQs	15

1 The brief introduction of WIFI module

1.1 Contents of the accessory pack

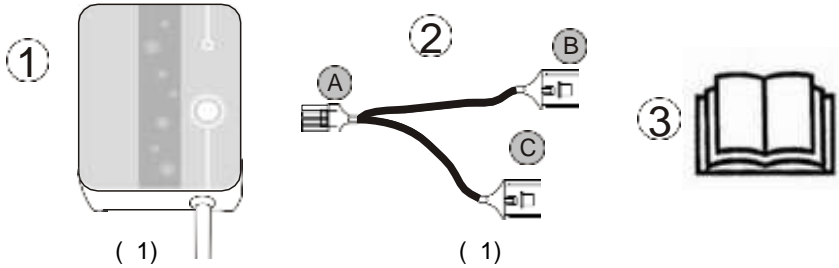

Or

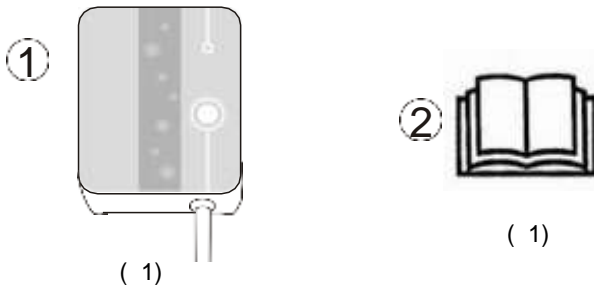

1.2 Description of the WIFI module

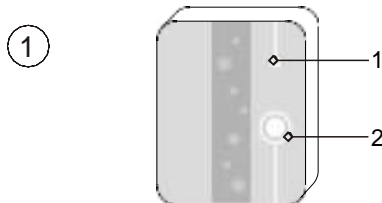

1	LED lights(on = green)
2	Network configuration button

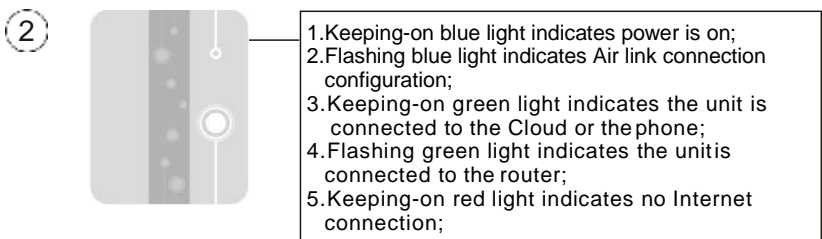

2 The installation of WIFI module

2.1 Opening the heat pump

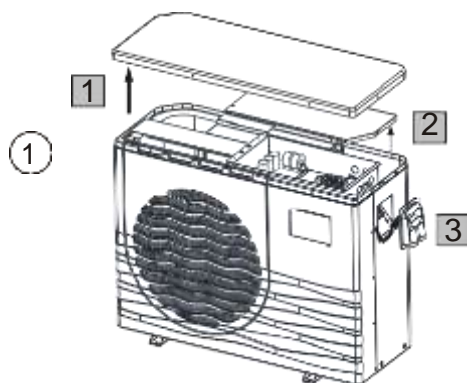

2.2 Connection

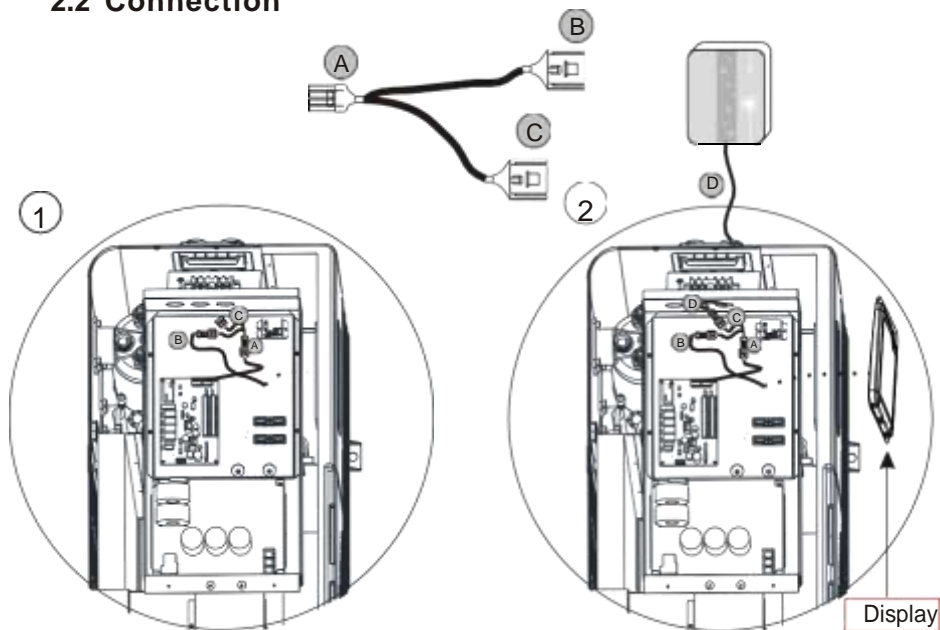

Without WiFi module

With WiFi module

2.3 Reinstall

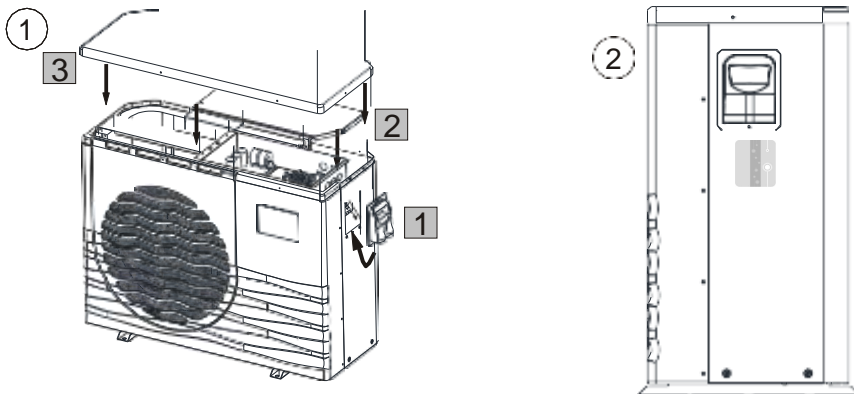

3 The using of WIFI module

3.1 Wifi module work



You need to prepare intelligent terminals (such as mobile devices), networks (such as routers), than you can achieve remote control. Connections are as follows:

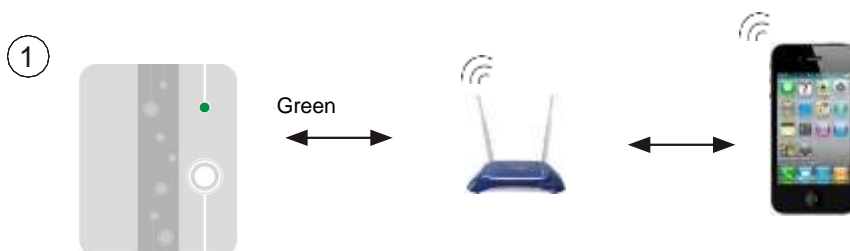

3.2 Download the APP

For the Android version: Search `InverterTemp` in the Google play,download it and then install it.

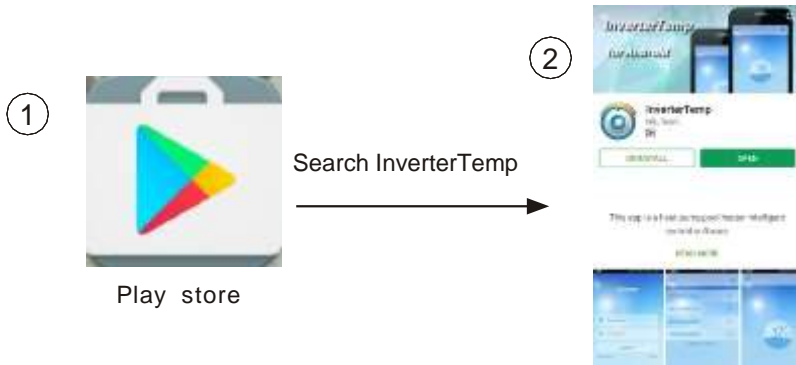

For the IOS version: Search `InverterTemp` in the APP store,,download it and then install it.

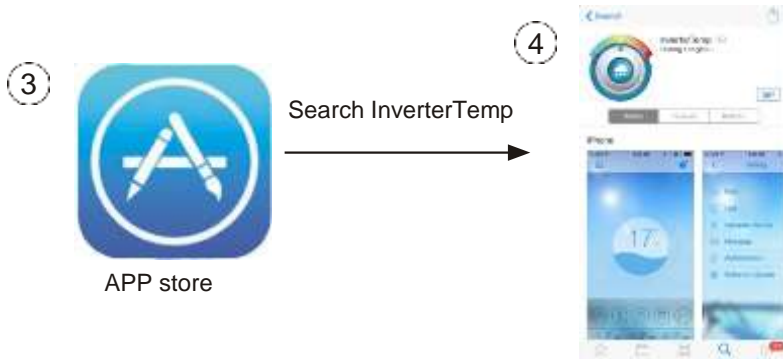

3.3 Register

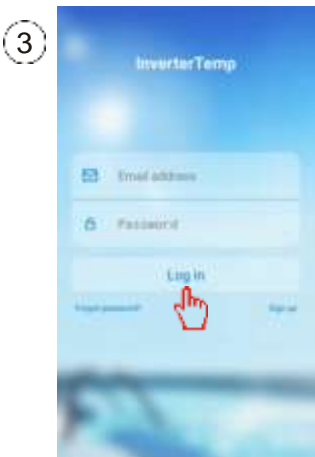
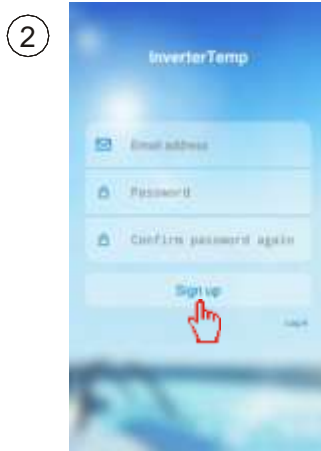

3.4 Configuration of WIFI module

Note: Confirm the APP has been connected to the valid WIFI

input the correct password,
then press to next step



Press the button of WIFI module
as below picture



After press the button,
the light will be blue

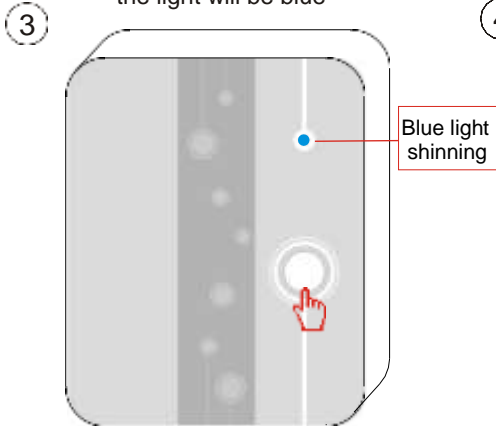

Note:On WIFI module

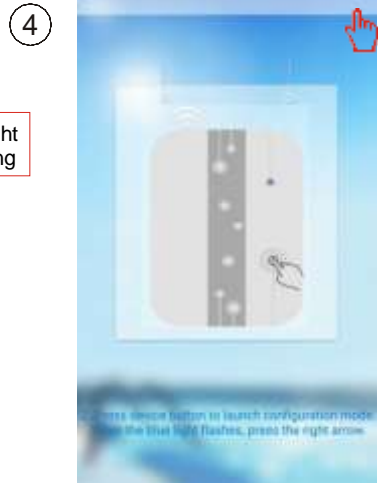

Reading configuration

⑤



Successful configuration

⑥



Loading configuration failed

⑦

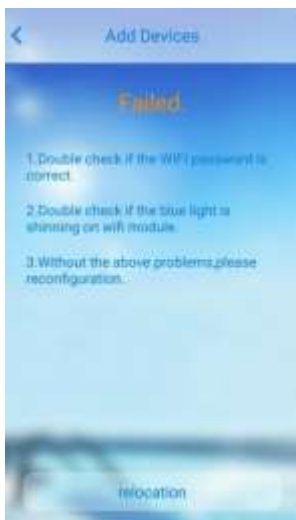

Reconfiguration

⑧





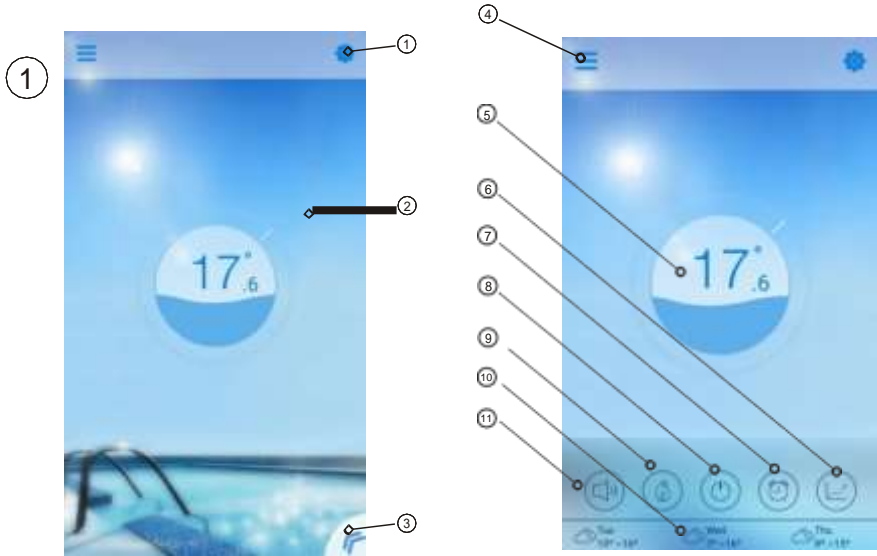

4 Operation and Application of APP

4.1 The main icon and function

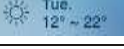

NO.	ICON	NAME	FUNCTIONS
①		Setting	Press to set the software.(see page.14)
②		Target temp. Pointer	Press and hold to slide and adjust target temperature(see page.11)
③		Menu button	Press the menu button, it will show the function list.
④		Device list	Device list, press it and goes to device list.
⑤		Status Display	The number show the current pool water temperature .Ripple on behalf of the machine switch.
⑥		Temperature curve	Press to show the temperature curve about latest temperature record in a month.(see page.13).
⑦		timer	Click it to enter the timer on/off and mute timer setting interface(see page.11).

⑧		On/off button	Press to control the on/off state of the unit.
⑨		Mode shift	Click it to shift running mode of equipment among three modes: Cooling, heating and Auto. The cooling mode does not display this icon. (see page.10.)
⑩		Weather	Display the weather in three days
⑪		Mute conversion	Click it to shift running mode of equipment among two modes: mute and un-mute (see page.12)

4.2 Main Function

4.2.1 Turn ON/OFF



Operation and Use

4.2.2 Mode s shifting

Click the "Mode shift" icon to shift running mode of equipment.

The sequence of shifting is "Cooling → Heating → Auto" and that cycle repeats.

①



Interface of cooling mode

②



Interface of heating mode

Shift to Heating mode



Auto mode

③



Shift to Cooling mode



Shift to Auto mode



4.2.3 Setting the temperature

Hold the cursor slide to change the temperature



Complete the setting of target temp.



4.2.4 Timer setting

- (1) Click "Timer" icon to enter the timer setting interface.
- (2) Click "<" to return to previous interface.
- (3) 2 independent groups of timer are provided for setting.



Click characters to set timer



Operation and Use

Save it after setting

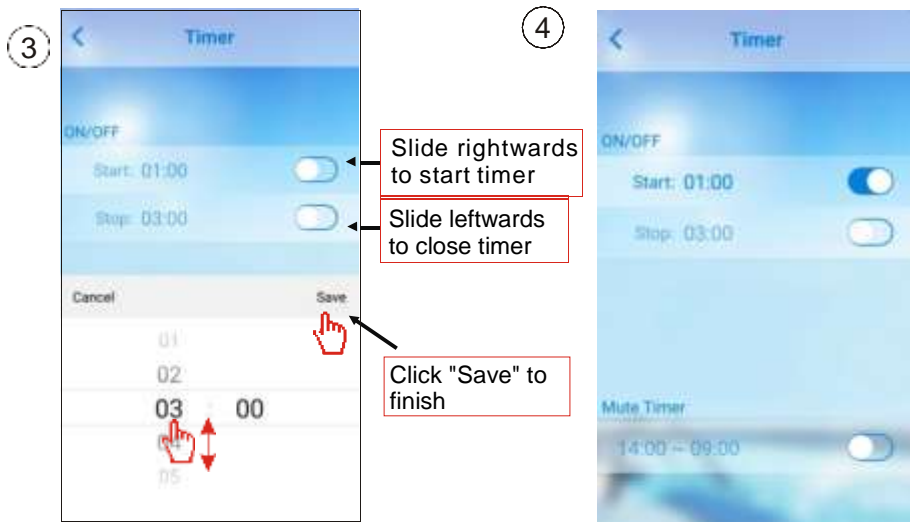

4.2.5 Silence Mode

Click “mute” icon to shift the Silence Mode(ON/OFF).

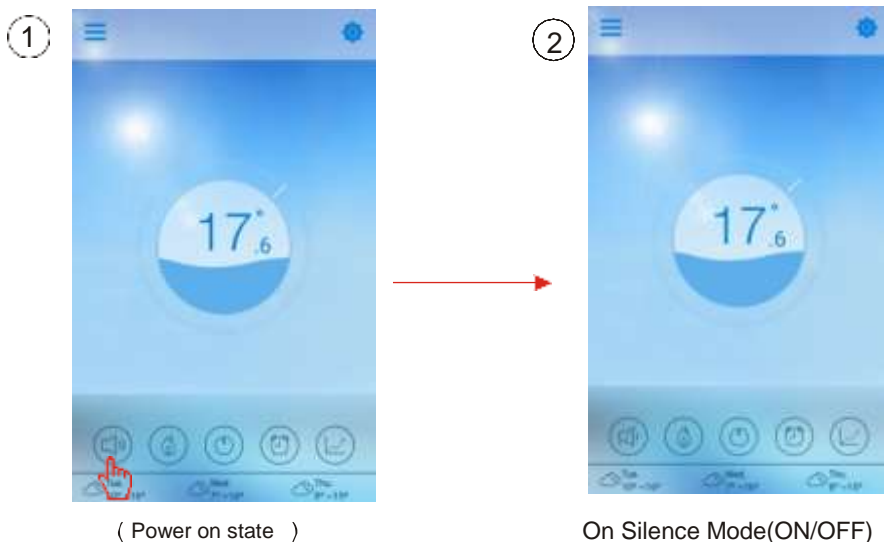

Operation and Use

4.2.6 Timing mute

Click "Timer" icon



Click to set the time



4.2.7 Check the Temp.curve

a. You can get current or history (up to past 30 days) information of variation of temperature by easily sliding the pointer.

b. With two fingers you can zoom in/out the Temp.curve.

Press the curve button

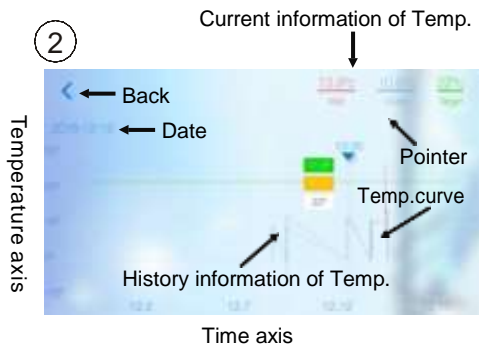

Interface of Temp.curve

4.3 Other Function

Click Settings icon to enter the interface of settings.



FAQ	ANSWER
Internet Access successful:	Green light
How to fix a connection issue due to a too big distance between my Home router and the WiFi module.	(1) Use a 10m extension cable, please contact your dealer. (2) Use a Wi-Fi range extender WiFi (not supplied).

Operation and Use

Check the Failure Information of heat pump

Click to check failure

①

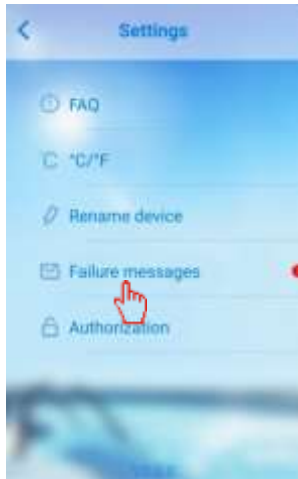

Fault record

②



Note: If the machine fails, please clear the fault promptly.

5.FAQ

5.1 when the APP can not connect the device, it shows Failed to connect to device

Answer: The network is abnormal, please check your network .

5.2 when the APP can not connect the device, it show Device offline

Answer: The WIFI module is dropped, please check the connection of the WIFI module, or restart and connect the module again

5.3 The distance between my device and router is too long which results in a signal instability.

Try to add another router between the original router and the equipment in order to relay Signal.

5.4 Something goes wrong with my equipment, what should I do?

- (1) Check error message in Setting (see page.20) or displayed in wire controller.
- (2) Look up corresponding error code in the instruction of your equipment to find out the problem.
- (3) Contact your supplier for after-sales maintenance if necessary.

Note: _____

Contact details

HeatPumps4Pools Ltd
Rosemary Lodge
Church Road
Ramsden Bellhouse
Essex
CM11 1RT
United Kingdom

Tel +44 1268 206560

www.HeatPumps4Pools.com

enquiries@heatpumps4pools.com



TM

